

CLEARANCES:

Install the oven with a minimum 1-inch clearance on sides and back to combustible construction. Consult the manual for enclosure instructions.

VENTING:

The oven can be vented in two methods:

1. Direct vent using 8 inch chimney pipe listed to UL 103 HT and installed per UL 737.
2. Indirect vent using Type 1 hood system installed per UL 2162.

SHELF:

Stainless steel shelf bolts to oven. Shelf to be covered with non-combustible material provided by installer.

WEIGHT: 3,800 lb

UTILITIES:

No electricity or gas required

NOTE:

The oven should be installed in accordance with all relevant local and national codes and in a manner acceptable to the authority having jurisdiction.*

* Progressive changes in technology and product development may necessitate changes to specifications without notice.

MUGNAINI

- SINCE 1989 -

MODEL : 140 PA
 SERIES : COMMERCIAL
 ENCLOSURE : NEO (WOOD)

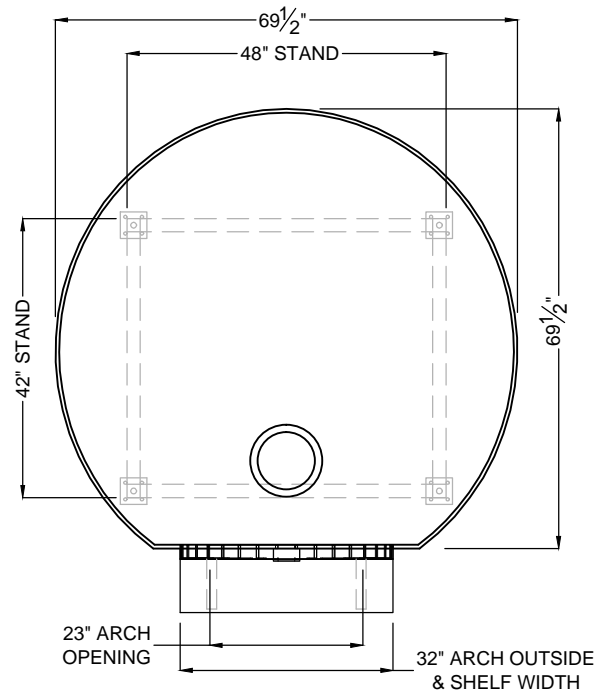

TOP VIEW

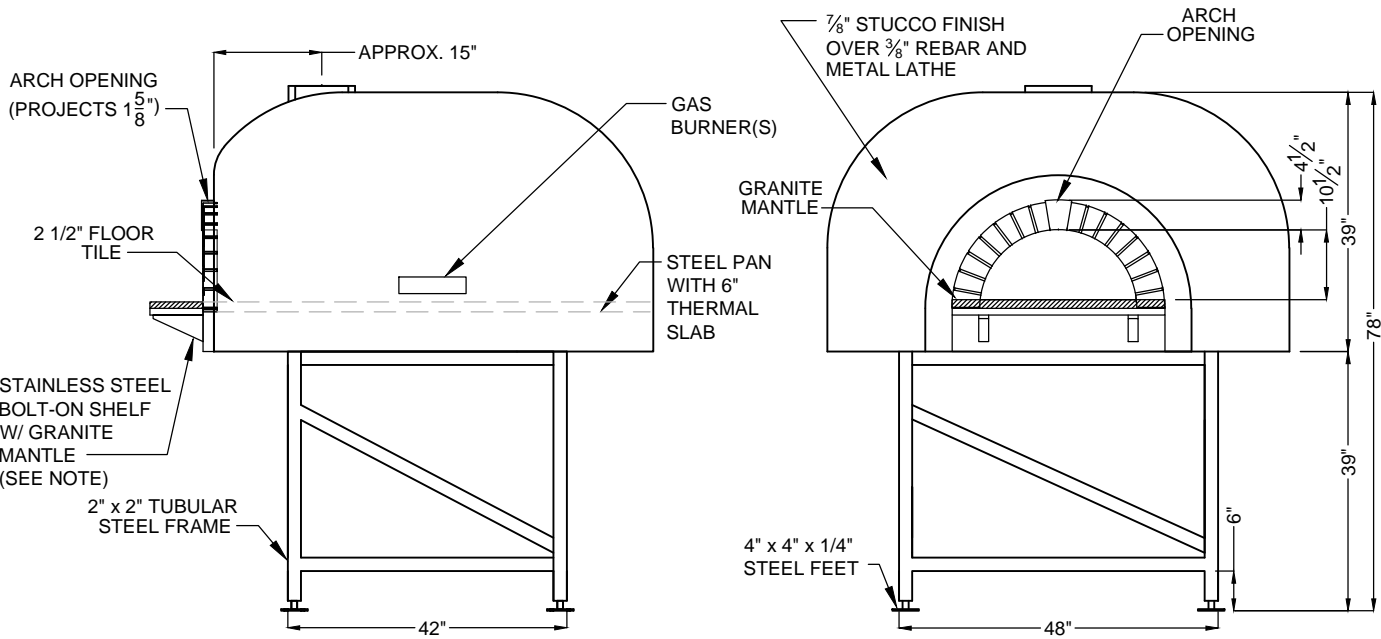

SIDE VIEW

FRONT VIEW