

CLEARANCES:

The oven shall be installed a minimum of 2" away from combustible material from back wall to oven and side wall to oven. You may bridge the gap between any wood framing and the oven by using metal framing with concrete board or masonry.

VENTING:

The oven is direct vented with a 8" chimney pipe listed to the UL 103 HT standard. The chimney starts with an anchor plate and requires a minimum rise of 36" for the oven to properly draft. The Chimney must terminate to a UL listed spark arrestor installed 2' taller than any structure within a 10' radius. Venting is not included as it varies depending on installation requirements.

SHELF:

Stainless steel shelf bolts to oven. Shelf to be covered with non-combustible material provided by installer.

WEIGHT: 2,300 lb **FLOOR HEIGHT:** 47 in.

UTILITIES:

No electricity or gas required

NOTE:

The oven should be installed in accordance with all relevant local and national codes and in a manner acceptable to the authority having jurisdiction.

Progressive changes in technology and product development may necessitate changes to specifications without notice.

** Allow +2" for all outside dimensions **

MUGNAINI

— SINCE 1989 —

MODEL : PRIMA 100 PA
SERIES : RESIDENTIAL
ENCLOSURE : BARREL (WOOD)

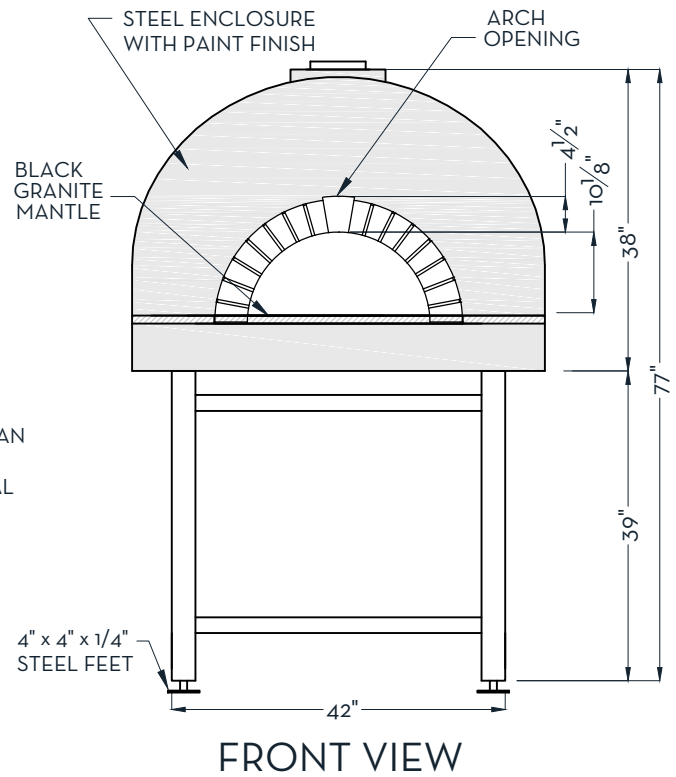
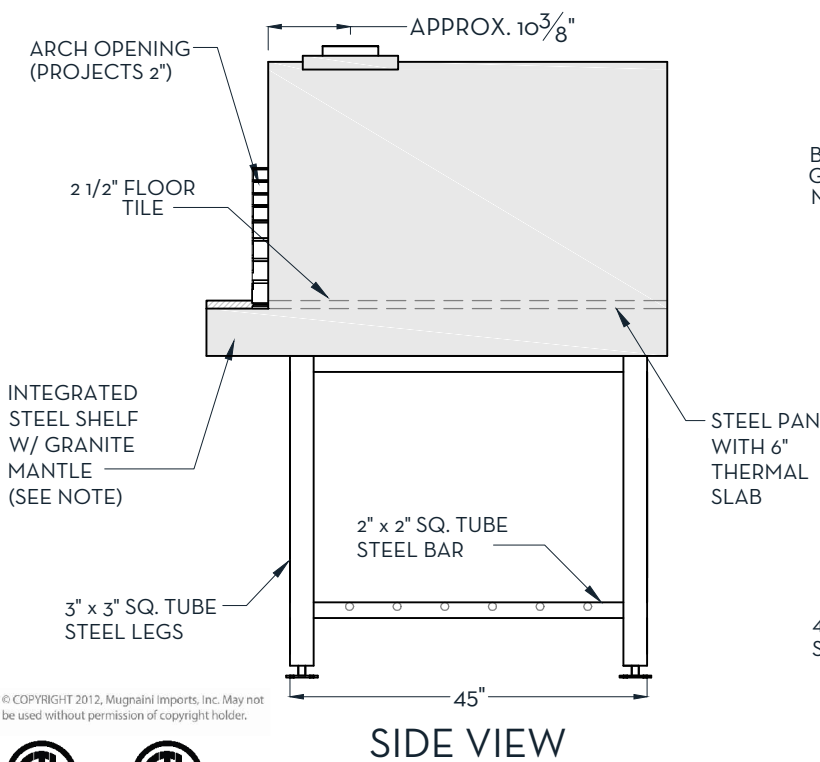
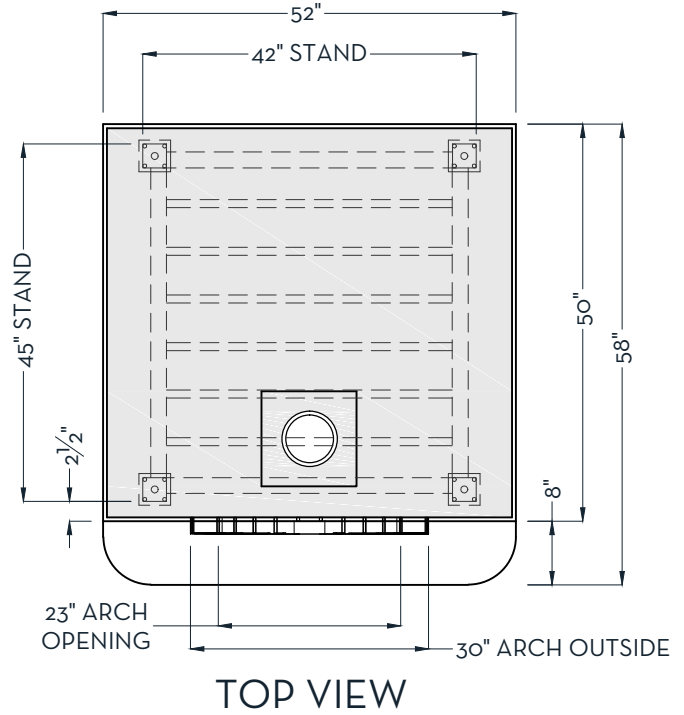

© COPYRIGHT 2012, Mugnaini Imports, Inc. May not be used without permission of copyright holder.



Intertek

UL 737



Intertek

ANSI/NSF-4

Mugnaini Imports, Inc. • 1530 Grove Street, Healdsburg, CA 95448
main: (707) 416-4106 • toll free: (888) 887-7206 • fax: (707) 857-7177
mugnaini.com • mugnaini@mugnaini.com